

McIntosh
C 33

OWNER'S MANUAL

THE McINTOSH C 33 SOLID STATE STEREO PREAMPLIFIER



Reading Time: 43 Minutes

Price \$2.00

VARIOUS REGULATORY AGENCIES REQUIRE THAT WE BRING THE FOLLOWING INFORMATION TO YOUR ATTENTION. PLEASE READ IT CAREFULLY.

WARNING: TO PREVENT FIRE OR SHOCK HAZARD, DO NOT EXPOSE THIS UNIT TO RAIN OR MOISTURE.

The McIntosh you have purchased is a Model C 33. It has a serial number located on the rear panel of the chassis. Record that serial number here:

Serial Number

The model, serial number and purchase date are important to you for any future service. Record the purchase date here:

Purchase date

Upon application, McIntosh Laboratory provides a Three-Year Service Contract. Your McIntosh Authorized Service Agency can expedite repairs when you provide the Service Contract with the instrument for repair. To assist, record your Service Contract number here:

Service Contract Number

Your C 33 Stereo Preamplifier is designed to perform to its specifications for many years. If you have any questions, please contact:

CUSTOMER SERVICE

McIntosh Laboratory Inc.
2 Chambers Street
Binghamton, New York 13903-9990
Phone: 607-723-3512

**Take Advantage of 3 years
of Contract Service...
Fill in the Application NOW.**

Contents

INTRODUCTION	2
SIMPLIFIED BLOCK DIAGRAM.....	3
INSTALLATION.....	4
SIMPLIFIED CONNECTING DIAGRAM.....	6
HOW TO CONNECT.....	7
USING THE FRONT PANEL CONTROLS.....	12
USING THE PUSHBUTTONS.....	15
TOP PANEL INFORMATION AND SECONDARY CONTROLS.....	17
PERFORMANCE LIMITS AND RATINGS.....	18
PERFORMANCE CHARTS.....	19
TECHNICAL DESCRIPTION.....	22
BLOCK DIAGRAM.....	24

McINTOSH THREE YEAR SERVICE CONTRACT

An application for A THREE YEAR SERVICE CONTRACT is included with this manual.

The terms of the contract are:

1. McIntosh will provide all parts, materials and labor needed to return the measured performance of the instrument to the original performance limits. The SERVICE CONTRACT does not cover any shipping costs to and from the authorized service agency or the factory.
2. Any McIntosh authorized service agency will repair McIntosh instruments at normal service rates. To receive service under the terms of the SERVICE CONTRACT, the SERVICE CONTRACT CERTIFICATE must be presented when the instrument is taken to the service agency.
3. Always have service done by a McIntosh authorized service agency. If the instrument is modified or damaged as a result of unauthorized repair, the SERVICE CONTRACT will be cancelled. Damage by improper use or mishandling is not covered by the SERVICE CONTRACT.
4. The SERVICE CONTRACT is issued to you as the original purchaser. To protect you from misrepresentation, this contract cannot be transferred to a second owner.
5. To receive the SERVICE CONTRACT, your purchase must be made from a McIntosh franchised dealer.
6. Your completely filled in application for the SERVICE CONTRACT must be post-marked within 30 days of the date of purchase of the instrument.
7. To receive the SERVICE CONTRACT, all information on the application must be filled in. The SERVICE CONTRACT will be issued when the completely filled in application is received by McIntosh Laboratory Incorporated in Binghamton, New York.
8. Units in operation outside the United States and Canada are not covered by the McIntosh SERVICE CONTRACT, regardless of the place of purchase. Nor are units acquired outside the U.S.A. and Canada, the purchasers of which should consult with their dealer to ascertain what, if any, service contract or warranty may be available locally.

Introduction

The McIntosh C 33 is a super quality, high performance Stereo Preamplifier. Its design has been governed by insistence on great flexibility, versatility, low distortion and high performance with long life.

The C 33 provides many features for your listening enjoyment. They include:

1. a dual preamplifier system with separate listen and record program lines, which allows listening to one program source while recording from a different independent program source.
2. a low noise electronic input switching system, which uses dual field effect transistors (FETs) and short signal leads to give great source to source isolation, low distortion, and freedom from noise and hum pickup.
3. two, seven source, input selector switches for 3 tape decks, 2 turntables, 1 tuner, and 1 auxiliary, which allow independent source selection for listening and recording.
4. an electronic record monitor switch, which allows the record program line to be heard through the main listen output.
5. a five band program equalizer, which permits the adjustment and improvement of the loudness contrast of the five most important frequency ranges. Each band can be emphasized or de-emphasized to satisfy your listening taste. The program equalizer can be switched to either the listen or record program lines. This allows equalizing the record output signal to tape recorders or equalizing the main listening output.
6. a precision volume control, which is electronically trimmed during manufacture to maintain channel to channel accuracy to better than 1 decibel (dB). This high order of accuracy assures continuing program balance as the listening volume is changed.
7. an active circuit loudness control, which is electrically independent of the volume control. Close conformity to the Fletcher-Munson equal loudness curves can be attained regardless of the volume control position.
8. high and low frequency filters, which reduce high frequency noise and low frequency rumble at a 12 dB per octave roll off rate.
9. a compandor, which permits expansion or compression of the dynamic range of program material from either the record tape output or the main listen output. Compressed recordings and broadcasts can be expanded on playback to restore their dynamic range. Tapes can be recorded using compression and replayed using expansion to increase signal-to-noise ratio.
10. front panel tape recorder jacks, which allow simple plug-in of an additional tape recorder without disconnecting your regular system. This makes tape copying to a portable recorder very convenient.
11. a tape recording program line, which makes it very easy to record phono, tuner, or auxiliary on up to 3 recorders at the same time (4 recorders when using the front panel tape recorder jacks) or to copy from recorder to recorder. Recording operations do not interfere with the separate listen program line.
12. an automatic AC power control circuit, which can conveniently turn off the entire stereo system when the turntable turns off.
13. a built-in monitor amplifier, which provides 20 watts per channel power output and includes the McIntosh patented Power Guard protection circuit. The monitor amplifier can be operated from the listen program line, the record program line, or independently from a separate external source.
14. two front panel headphone jacks, which are powered by the internal monitor amplifier.
15. two speaker output pushbuttons, which control the operation of two sets of loudspeakers (when used with the optional SCR-2 speaker control relay) or two sets of power amplifiers.
16. electronically regulated power supplies, which maintain stable operation even during periods of low line voltage.

This outstanding preamplifier will serve you best when you understand its functions and what it is designed to do. Some time invested with this manual will be valuable in your knowledge of how it works. The simplified block diagram on page 3 shows how the C 33's internal circuits are arranged. The simplified connecting diagram on page 6 shows how other components are connected to the C 33.

Simplified Block Diagram

One Channel Shown, Other Channel Identical

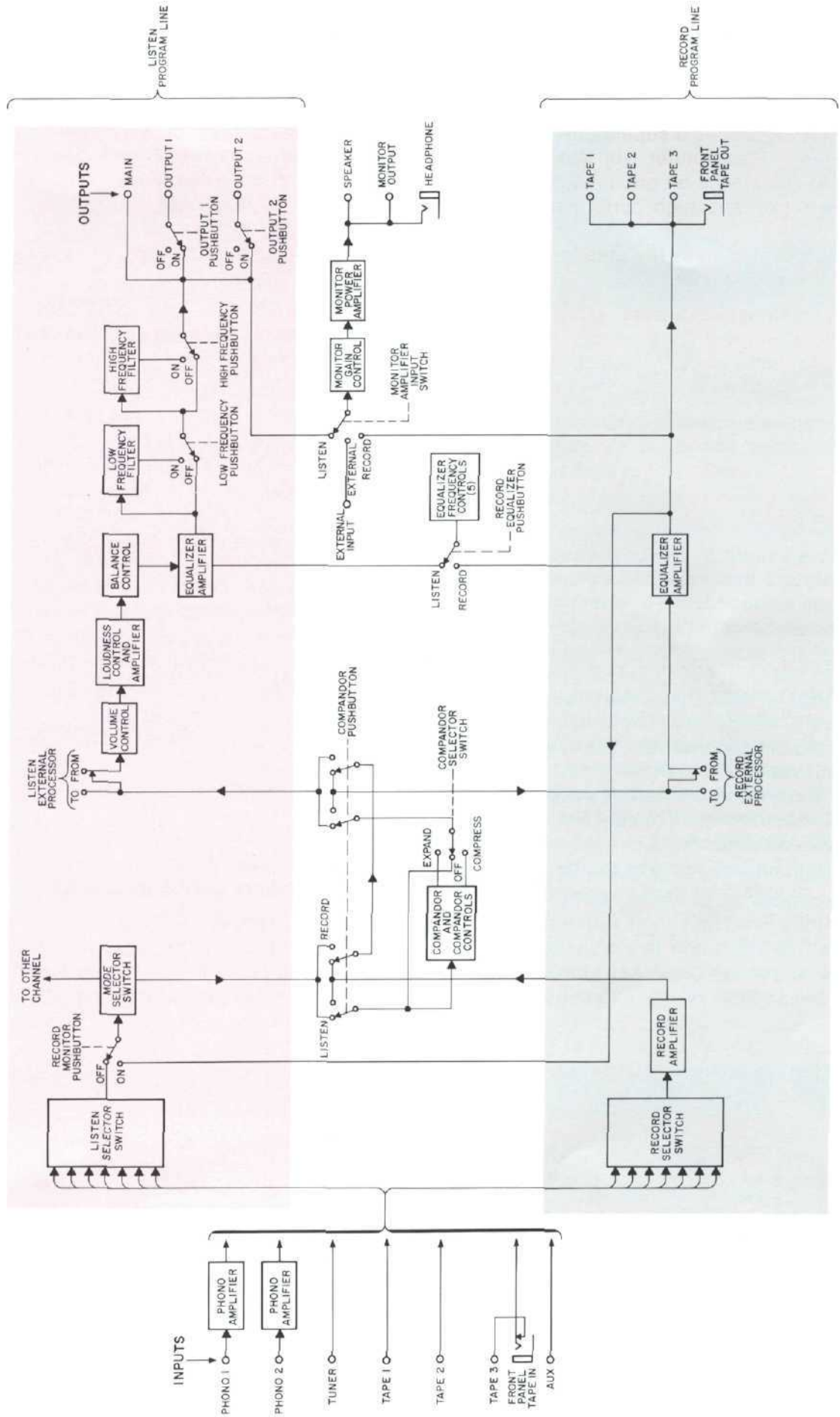

McINTOSH C 33 STEREO PREAMPLIFIER



from the top. With adequate ventilation the instrument can be mounted in any position. The recommended minimum space for installation is 15 inches (38.1 cm) deep, 17 inches (43.2 cm) wide, and 6 inches (15.2 cm) high.

To install the instrument in a McIntosh cabinet, follow the instructions that are enclosed with the cabinet. For any other type of installation, follow these instructions:

1. Unpack from Carton

Open the carton and remove the PANLOC brackets, hardware package, and mounting template. Remove the C 33 from its plastic bag and place it upside down on the shipping pallet, then unscrew the four plastic feet from the bottom of the chassis.

2. Mark the Cabinet Panel

Place the mounting template in the position on the cabinet panel where the instrument is to be installed, and tape it in place. The broken lines that represent the outline of the rectangular cutout also represent the outside dimensions of the chassis. Make sure these lines clear shelves, partitions, or any equipment. With the template in place, first mark the six A and B holes and the four small holes that locate the corners of the cutout. Then, join the four corner markings with pencil lines using the edge of the template as a straight edge.

3. Drill Holes

Use a drill with a 3/16 inch (5 mm) bit held perpendicular to the panel and drill the six A and B holes. Then, using a drill bit slightly larger than the tip of your saw blade, drill one hole at each of two diagonally opposite corners. The holes should barely touch the inside edge of the penciled outline. **Before taking the next step, make sure that the six A and B holes have been drilled.**

4. Saw the Panel Cutout

Saw carefully on the inside of the penciled lines. First make the two long cuts and then the two short cuts. After the rectangular opening has been cut out,

The PANLOC system of installing equipment conveniently and securely is a direct result of McIntosh research. By depressing the two PANLOC buttons on the front panel, the instrument can be either locked firmly in place or it can be unlocked so that the chassis can slide forward, giving you easy access to the top and rear panels.

The trouble-free life of an electronic instrument is greatly extended by providing sufficient ventilation to prevent the build-up of high internal temperatures that cause deterioration of component parts. You should allow enough clearance so that cool air can enter at the bottom of the cabinet and be vented

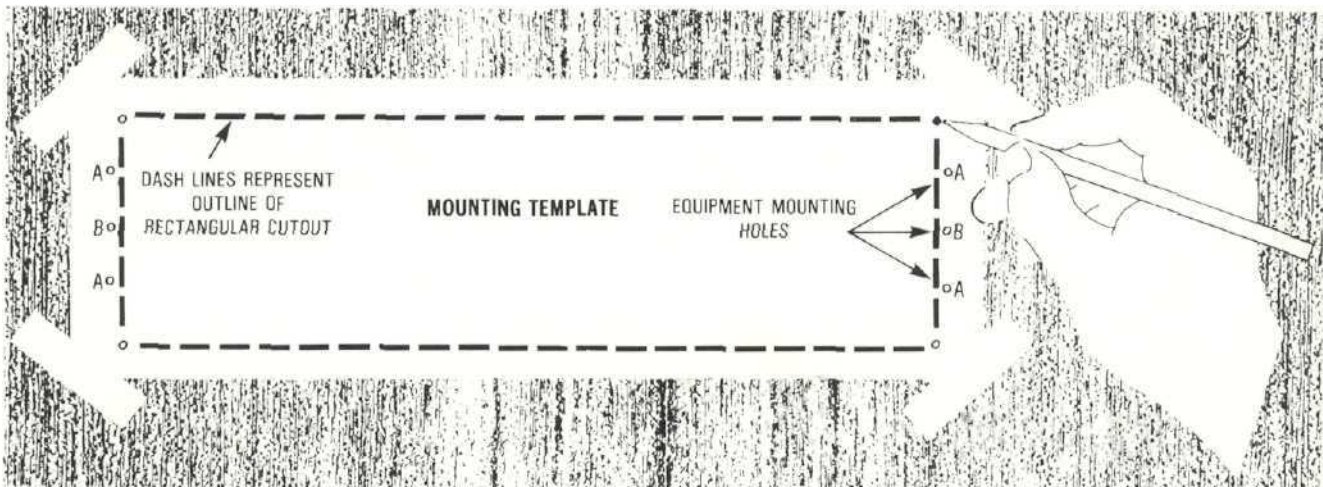

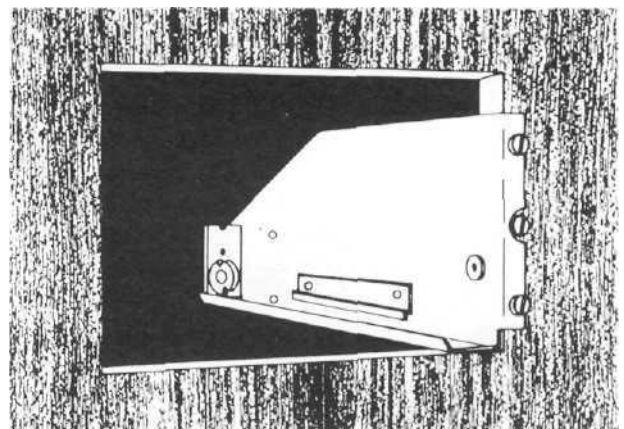
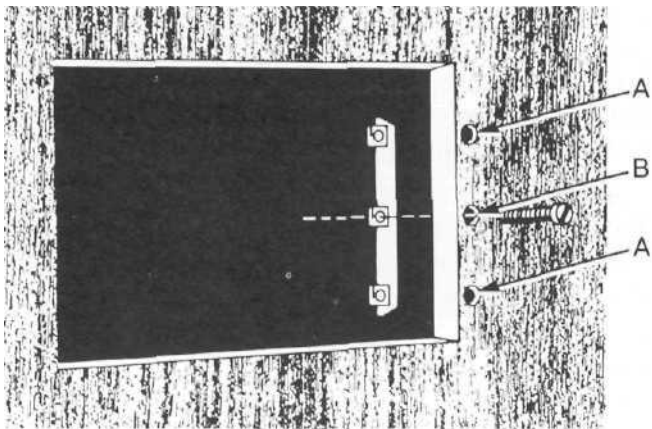

use a file to square the corners and smooth any irregularities in the cut edges,

5. Install the Mounting Strips

In the hardware package you will find two mounting strips and two sets of machine screws. For panels that are less than ½ inch (12.7 mm) thick, use the ¾ inch (19.1 mm) screws; for panels that are more than ½ inch (12.7 mm) thick, use the 1¼ inch (31.8 mm) screws.

Starting at the right-hand side of the panel, insert a screw of proper length into the center hole in the panel, marked B on the template. On the back of the panel, align a mounting strip with the holes in the panel and tighten the screw in the center hole until the screwhead is pulled slightly into the wood.

Repeat this procedure to attach the mounting strip to the left side of the panel.

6. Attach the PANLOC Brackets

Using two screws of proper length in the A holes on each side, attach the PANLOC brackets to the cabi-

net panel; the short flange is mounted against the front (face) of the cabinet panel. The screws pass through the PANLOC bracket flange, the cabinet panel, and then through the mounting strips previously mounted.

7. Install the Instrument

Guide the AC power cord through the panel opening to the back of the cabinet; then, slide the instrument into the opening carefully so that the rails on the bottom of each side of the chassis engage the tracks on the mounting brackets. Continue to slide the instrument into the cabinet until it is stopped by the adjust position latches. Press the latches inward, this permits the instrument to slide into the cabinet until its front panel is flush with the cabinet panel. Depress the PANLOC buttons at the lower left and right corners of the instrument panel to lock the unit firmly in the cabinet. Depressing the PANLOC buttons again will unlock the instrument so that it can slide forward to the adjust position; if you press inward on the adjust position latches then you can remove the instrument from the cabinet.

Simplified Connecting Diagram

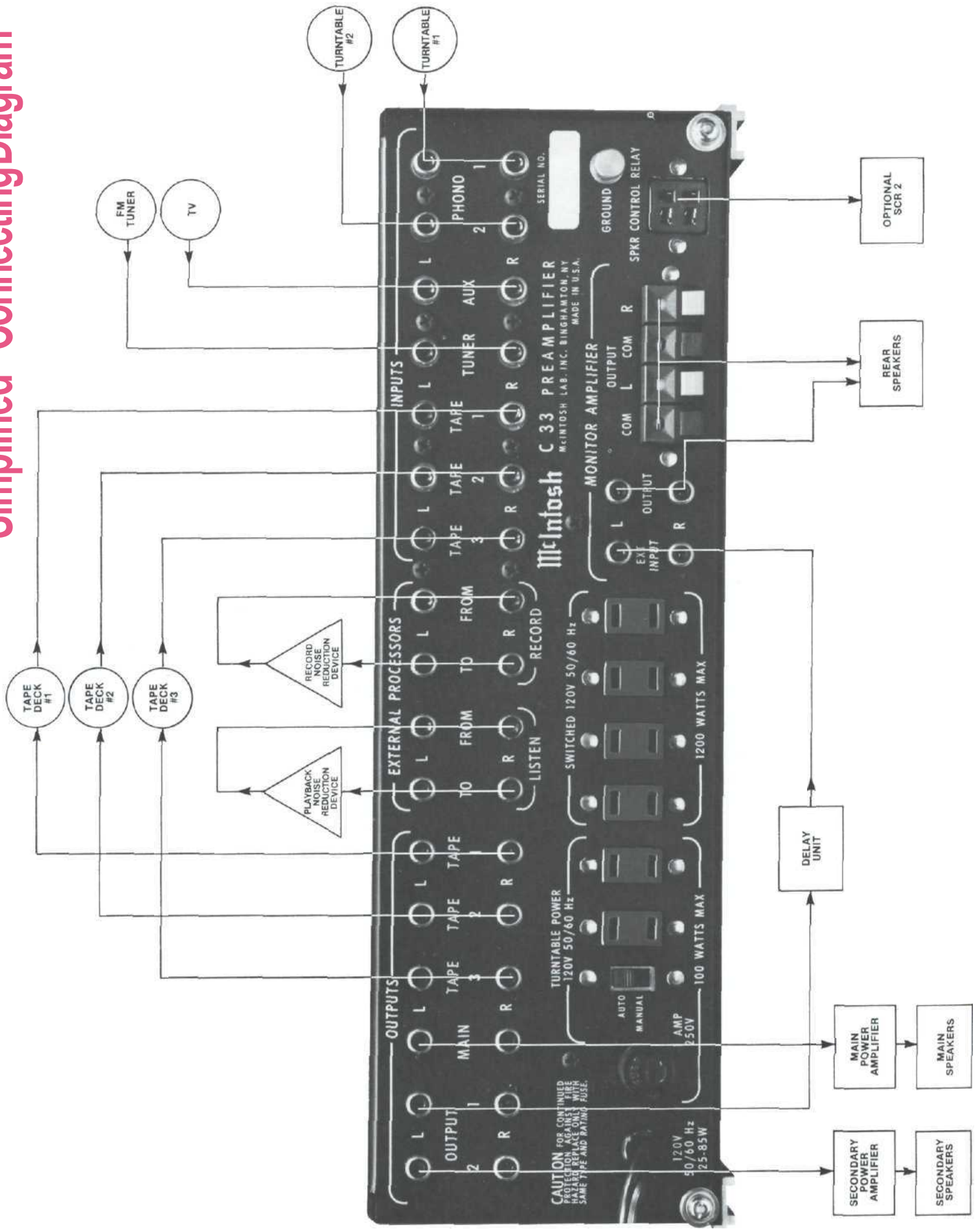

How to Connect



Rear panel input jacks are provided for 2 stereo turntables, PHONO 1 and PHONO 2; a stereo tuner, TUNER; 3 stereo tape recorders, TAPE 1, TAPE 2, and TAPE 3; and an auxiliary high level source, AUX.

Rear panel output jacks are provided to feed 3 stereo tape recorders, TAPE 1, TAPE 2, and TAPE 3; and 3 stereo 2.5 volt listen program line outputs, MAIN, OUTPUT 1, and OUTPUT 2. Two sets of jacks, EXTERNAL PROCESSORS; LISTEN and RECORD, are provided to connect noise reduction units or other signal processing devices. Monitor amplifier EXT INPUT jacks, OUTPUT jacks and speaker terminals allow connecting to and from the monitor amplifier.

CONNECTING TURNTABLES

Connect the cable from the left channel of the turntable into the Left PHONO 1 INPUT jack. Connect the cable from the right channel of the turntable into the Right PHONO 1 INPUT jack. For a second turntable, connect PHONO 2 in the same way. The C 33 uses automatic shorting jacks for the PHONO inputs. If the inputs are not connected, shorting plugs are not needed.

CONNECTING A STEREO TUNER

Connect the cable from the tuner left channel output to the Left TUNER INPUT jack.

Connect the cable from the tuner right channel output to the Right TUNER INPUT jack.

CONNECTING TAPE RECORDERS

To Record:

Connect a cable from the Left TAPE 1 OUTPUT jack to the left high level input of the tape recorder. Connect a cable from the Right TAPE 1 OUTPUT jack to the right high level input of the tape recorder. Connect a second and third recorder in the same manner to the TAPE 2 OUTPUT and TAPE 3 OUTPUT jacks.

To Playback/Monitor:

Connect a cable from the tape recorder left channel output to the Left TAPE 1 INPUT jack. Connect a cable from the tape recorder right channel output to

the Right TAPE 1 INPUT jack. Connect a second and third recorder in the same manner to the TAPE 2 INPUT and TAPE 3 INPUT jacks.

Front Panel Tape Recorder Jacks:

TAPE 3 recorder input and output connections are also available at the TAPE 3 IN-OUT jacks on the front panel. When a plug is inserted in the front panel TAPE IN jack the circuit to the rear panel TAPE 3 INPUT jacks will be disconnected. Inserting a plug in the front panel TAPE OUT jacks does not disconnect the rear panel TAPE 3 OUTPUT. Thus it is possible to record from the front panel TAPE OUT jack and the rear panel TAPE 3 OUTPUT jack at the same time but it is not possible to listen from the corresponding jacks at the same time. Metal shielded ¼ inch stereo phone plugs may be used. Connections are tip: left signal, ring: right signal, and sleeve: common ground.

CONNECTING AUX

Connect the left channel cable from any high level source (tuner, TV set, tape recorder, etc.) to the Left AUX INPUT jack. Connect the right channel cable to the Right AUX INPUT jack.

CONNECTING EXTERNAL PROCESSORS

There are two sets of EXTERNAL PROCESSOR jacks. One set is for LISTEN program lines and one set is for RECORD program lines. These jacks are used to connect to and from a noise reduction unit or to and from any other signal processing device. Be sure to match left to left and right to right channels when connecting external processors.

When connections are made to the EXTERNAL PROCESSOR from jacks, the signal path is broken within the C 33. THE PROCESSOR MUST BE TURNED ON FOR THE PROGRAM TO PASS THROUGH THE SYSTEM.

CONNECTING TO POWER AMPLIFIERS

Connect the MAIN OUTPUT jacks to the input of a stereo power amplifier. The Left MAIN jack connects to the amplifier left input jack. The Right MAIN jack connects to the amplifier right input jack.

Two stereo power amplifiers or two delay units may be connected in the same fashion to the OUTPUT 1 and OUTPUT 2 jacks. Audio output signal is supplied to these jacks only when the front panel pushbutton SPEAKER/OUTPUT 1 and/or 2 pushbuttons are pushed. This arrangement is useful for large systems where separate amplifiers and loudspeakers are used at distant locations.

SPEAKER CONTROL RELAY (an optional accessory)

The SPEAKER CONTROL RELAY, or SCR, is designed to provide both speaker control switching and high power switched AC outlets. To control loudspeakers, SPEAKERS 1 and 2 pushbuttons on the front panel must be used. When this is done, OUTPUT jacks 1 and 2 are normally not used. The operation of output jacks and speaker control will otherwise interfere with each other.

Plug the cable from the SCR into the C 33 back panel SPEAKER CONTROL RELAY receptacle. Connect the power amplifier output to the FROM POWER AMPLIFIER terminals on the SCR. Observe correct channel identification as well as correct polarity. The MAIN speakers (controlled by SPEAKER 1 pushbutton) are connected at the TO MAIN SPEAKER terminals. The REMOTE speakers (controlled by SPEAKER 2 pushbutton) are connected at the TO REMOTE SPEAKERS terminals. Again observe correct channel identification and polarity.

The SCR also has two AC power outlets that provide additional capacity of 2400 watts switched by the C 33. Use these outlets to supply AC power to amplifiers or other components whenever the total load to be switched by the C 33 exceeds the rating of 1200 watts. For proper operation, the cable from the SCR must remain connected to the SCR receptacle at the back of the C 33. Plug the SCR heavy line cord directly into a wall outlet. Do not plug it into the C 33. When the C 33 is turned on, power from the C 33 will energize a relay in the SCR which connects the two SCR AC outlets directly to the wall outlet.

MONITOR AMPLIFIER

Although its primary purpose is to drive headphones, the monitor amplifier can also be used to drive speakers. This eliminates the need for a separate stereo monitor amplifier. The monitor amplifier will furnish 20 watts per channel into 8 ohms or 12.6 volts RMS into a 600 ohm line. For operation see MONITOR AMPLIFIER page 17. The speakers can be connected to the red and black output terminals at the rear of the C 33. Connect the left speaker minus lead to the black OUTPUT COM terminal closest to the center of the C 33. Connect the left plus speaker lead to the red OUTPUT L terminal. Connect the right speaker minus lead to the black OUTPUT COM ter-

terminal closest to the C 33 ground terminal. Connect the right plus lead to the red OUTPUT R terminal. Resistance of the speaker hookup wire should be kept less than 0.5 ohms to avoid losses and response changes.

The monitor OUTPUT jacks can be connected to drive a low impedance (**8Ω to 600Ω**) unbalanced line. The INPUT jacks are used when an external source is fed to the monitor amplifier.

CONNECTING AC POWER

The preamplifier AC power cord is to be plugged into a 120 volt 60 Hz wall outlet.

Two types of AC power outlets are on the back panel of the C 33. Four are black and two are green.

The black outlets are switched on and off when the C 33 is turned on and off. These are intended for power amplifiers, equalizers, and others accessories totaling up to 1200 watts capacity.

The green AC power outlets are on at all times and are for use only with turntables. Do not use them for any other purpose. The turntable can be used as a power switch as described in the following section.

USING THE TURNTABLE AS A POWER SWITCH

If a turntable is used with the C 33, it can often be used to turn your entire system on and off. The turntable must be plugged into one of the green AC outlets at the rear of the C 33. The AUTO/MANUAL switch also at the rear must be in the AUTO position. When you switch on the power to the turntable, a special sensor circuit will detect the current drain of the turntable and will turn on the C 33 the same way the red POWER pushbutton does. The red pushbutton must be in the OFF or out position to do this. Read the section on AUTO-ON SENSIVITY on page 17 before using this feature.

CONNECTING PROGRAM SOURCE GROUNDS

A GROUND post is provided to connect the grounds from record changers, tape decks, etc. To prevent hum pick-up, the left and right program cables and the ground wire from that source should be wound or twisted together. Make sure the ground wire does not make any connection to the shields of the left and right program cables as they run between the source and the input of the preamplifier.

FUSE

A 1.0 AMP fast acting fuse protects the C 33 turntable current sensing circuits and the green AC turntable outlets. The fuse does not protect equipment connected to the black AC outlets. This fuse must be replaced with the same type and rating. Do not use SLO BLO fuses.

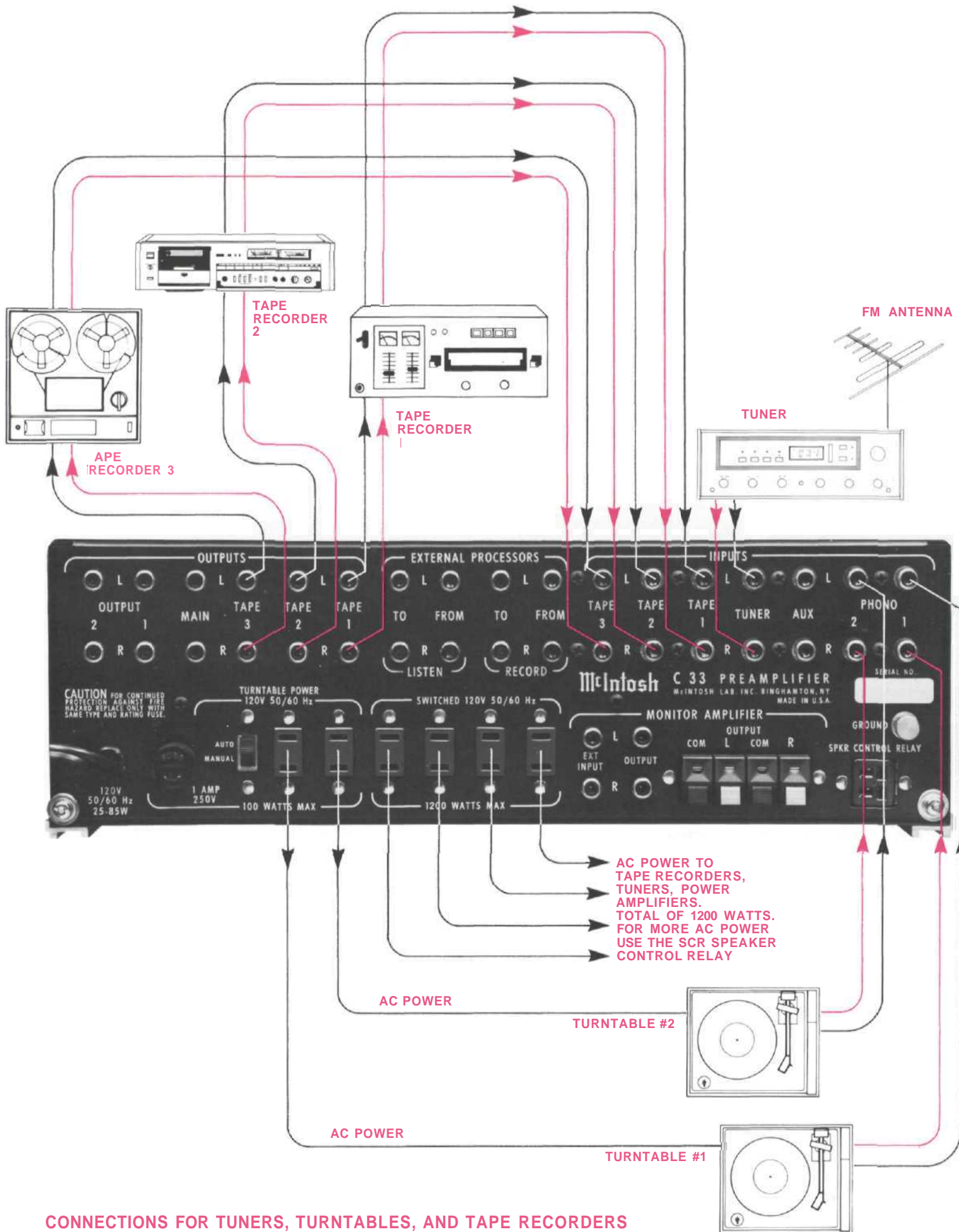

CONNECTIONS FOR TUNERS, TURNTABLES, AND TAPE RECORDERS

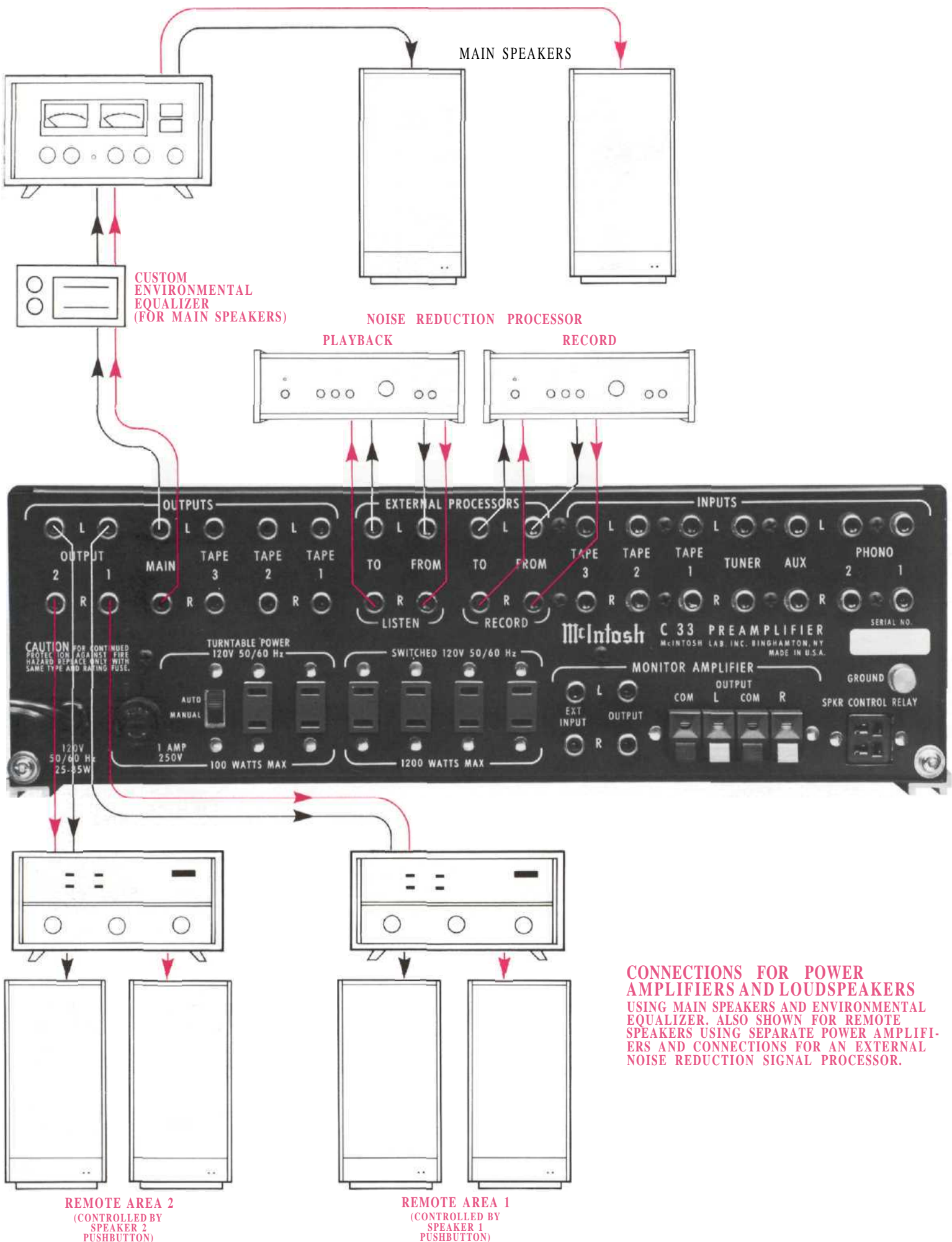

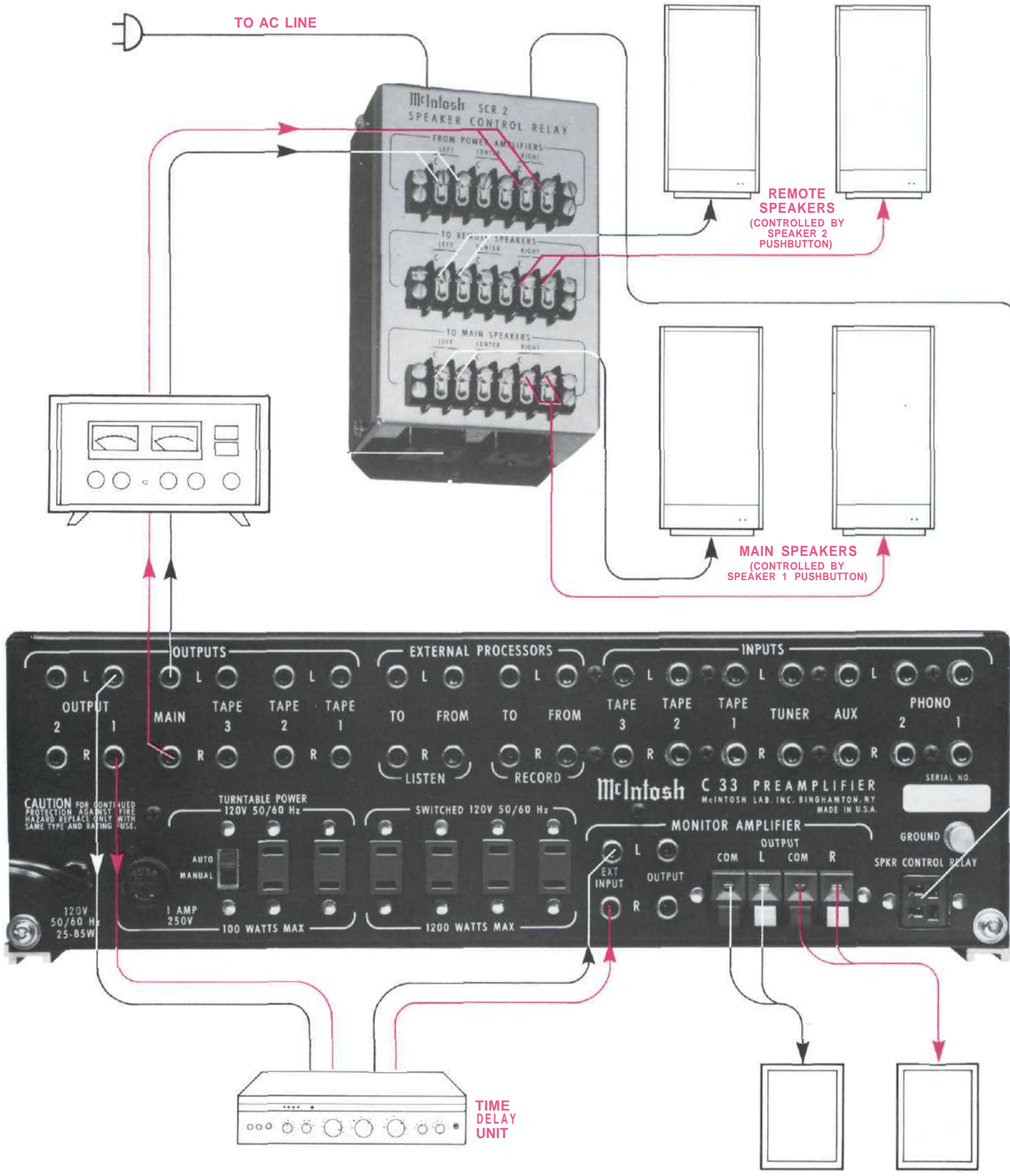

CONNECTIONS FOR POWER AMPLIFIERS AND LOUDSPEAKERS
 USING OPTIONAL SCR-2 SPEAKER CONTROL RELAY. CONNECTIONS ALSO
 SHOWN FOR TIME DELAY UNIT AND MONITOR AMPLIFIER LOUDSPEAKERS.
 THE SPEAKER/OUTPUT 1 PUSHBUTTON WILL TURN ON AND OFF THE MAIN
 SPEAKERS AND THE TIME DELAYED PROGRAM. IF THE SCR 2 IS NOT USED
 THE PUSHBUTTON WILL TURN ON AND OFF ONLY THE TIME DELAYED PROGRAM.

MONITOR AMPLIFIER SPEAKERS
 TO REPRODUCE
 TIME DELAYED
 PROGRAM

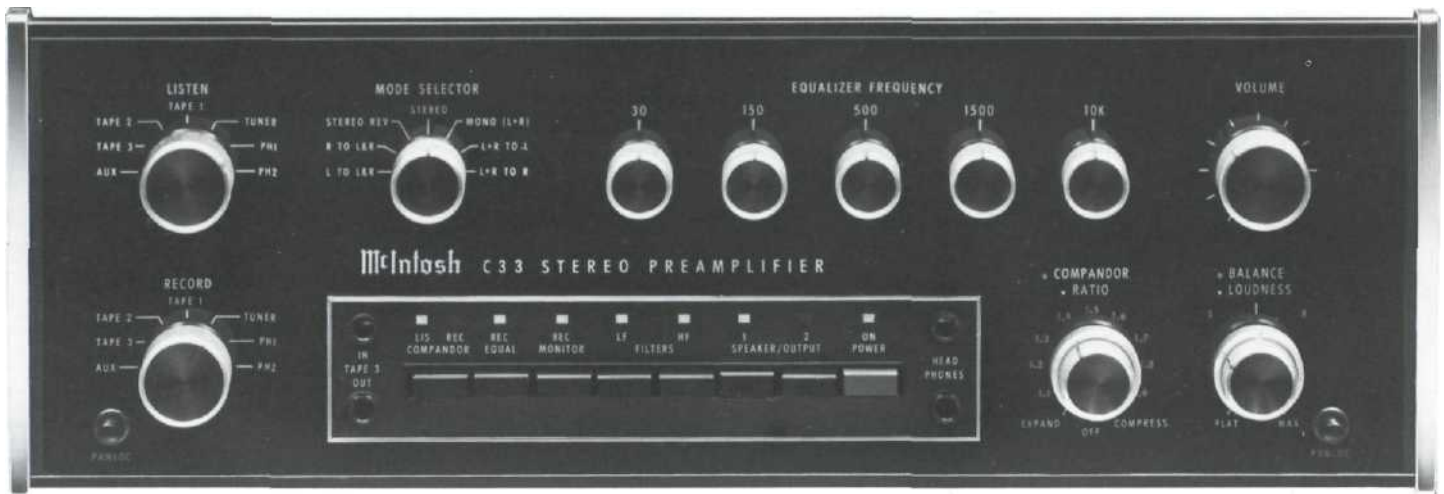

Using the Front Panel Controls



LISTEN AND RECORD SELECTOR SWITCHES

The LISTEN input selector switch is located at the upper left on the front panel. This is used to select the input for the LISTEN program

line. The LISTEN program line feeds the main output for the system power amplifier and loudspeakers.

The RECORD input selector switch is located at the lower left on the front panel. This control is used to select the input for the RECORD program line. The RECORD program line feeds the record output for tape recorders. To make a tape recording, turn the RECORD selector to the input program to be recorded. To copy a tape, turn this control to select the recorder on which the tape is to be played. This can be TAPE 1, 2, or 3. Copies can then be made on the other recorders connected to the C 33. The COMPANDOR, RECord EQUALizer, and RECord MONITOR pushbuttons can be used when making recordings. Refer to the description of these controls on Page 15 for their operation.



MODE SELECTOR

The MODE SELECTOR allows you to identify each stereo channel, create monophonic program material, and direct program material to one

channel or the other. This selector is used only in the LISTEN program line.

It controls the program in seven ways:

L TO L&R: Connects the left input to both left and

right output circuits.

R TO L&R: Connects the right input to both left and right output circuits.

STEREO REV: Connects the left input to the right output circuit and the right input to the left output circuit.

STEREO: Connects the left input to the left output circuit and the right input to the right output circuit. Use this STEREO position for normal listening.

MONO (L + R): Adds the left and right inputs together and connects to both output circuits.

L + R TO L: Connects the left plus right program to the left output circuit only.

L + R TO R: Connects the left plus right program to the right output circuit only.

EQUALIZER FREQUENCY CONTROLS

Each of five EQUALIZER FREQUENCY controls raises or lowers the amplitude of a band of frequencies centered on the frequency marked above the control. Both left and right channels are affected. The center, or flat position of the control has a detent for easy reference.



Use the EQUALIZER FREQUENCY controls to modify the sound and balance of program material. Here are some suggestions from which to start.

<u>Problem</u>	<u>Equalizer Correction</u>
Deep bass too weak	Raise 30
All bass weak	Raise 30 and 150
Voice reinforcement	Lower 150 and raise 500
Hum on program	Reduce 30 and 150
Violins, trumpets dull	Raise 1500
Cymballs not audible	Raise 10 K

The EQUALIZER FREQUENCY controls can be switched to either the LISTEN or RECORD program lines by the RECORD EQUALizer pushbutton. The equalizer circuit is located after the COMPANDOR circuit. Using the equalizer will not influence the behavior of the COMPANDOR.

BALANCE AND LOUDNESS

The BALANCE and LOUDNESS controls are concentric. The BALANCE control (large outer knob) adjusts the volume of the channels relative to each other.

L-LEFT...turning the control to the left accents the left channel by reducing the right channel output.



R-RIGHT...turning the control to the right accents the right channel by reducing the left channel output.

LOUDNESS

The LOUDNESS control (small center knob) provides a frequency response contour which compensates for the behavior of the human ear at lower listening levels. This contour is accurately modeled after the family of "equal loudness" curves identified by Fletcher and Munson. At the fully counterclockwise detented FLAT position, the loudness contour is electrically flat. As the control is turned clockwise, both bass and treble frequencies increase in the correct proportion. The contour is not affected by different settings of the VOLUME control. After setting the VOLUME control for the desired listening level, adjust the loudness control for the preferred compensation.



COMPANDOR SYSTEM

The McIntosh Compandor System can be used to control the dynamic range of program material. It can be used in two different ways. The circuits can be switched to function as an expander or as a compressor. Expansion increases the dynamic range of program material. This can be used to restore compressed material from tape recordings, records, or radio broadcasts. Compression decreases the dynamic

range. It can be used for making tape recordings or for listening to background music. The Compandor can be switched to either the record or listen lines. In this way you can make your own recordings using compression and then play them back using expansion.

The Compandor System has a total of four controls. The concentric COMPANDOR and RATIO controls are located on the front panel. The LEVEL MATCH and SPEED selector are located on the C 33 top panel.

COMPANDOR SELECTOR

The outer COMPANDOR knob can be set to EXPAND, OFF, or COMPRESS. When the COMPANDOR switch is in EXPAND or COMPRESS, a red light will appear above Listen or RECORD at the COMPANDOR pushbutton. In the center OFF position, the Compandor System is switched out of the circuit and the lights will be out. When the Compandor is not used, the selector should be placed in the OFF position.

RATIO CONTROL

The inner RATIO knob is used to control the amount of expansion or compression.

LEVEL MATCH

The LEVEL MATCH control on the top panel is used to restore the listening level when the expander or compressor is switched into the circuit.

SPEED

The SPEED selector on the top panel is used to control how fast the Compandor System responds to signals. By switching from FAST to NORMAL to SLOW, a more gradual rate of change in volume can be heard. Select the position that sounds best to you. If music with percussive instruments is used, NORMAL or FAST can provide very attractive sound. At the FAST speed the Compandor System follows changes quickly but will track low frequencies less accurately. Non-percussive music and voice require slower speed. At SLOW speed the low frequency tracking is accurate but the system will respond more slowly. The NORMAL position is best suited for most program material.

USING THE COMPANDOR AS AN EXPANDER

When the COMPANDOR selector is in the EXPAND position, the RATIO control is used to select the amount of expansion. Full counterclockwise rotation corresponds to a ratio of 1.0. This means that the dynamic range of the expander output is the same as the dynamic range of its input. Set the VOLUME control to a normal listening level. No change in dynamic range will be heard. As the RATIO control is increased clockwise, however, the output dynamic range becomes greater than the input. Set the RATIO control to the desired expansion

(usually between 1.2 and 1.5). Now switch the expander on and off. A change in the average listening level will usually be heard at this time. Adjust the LEVEL MATCH control until the average listening level matches as closely as possible when the expander is on and off. After this adjustment you will notice that with the expander on, loud passages will be louder and soft passages including noise will be softer.

When the RATIO control is at the fully clockwise position it corresponds to a ratio of 2.0. The output dynamic range is then twice the input dynamic range. This setting is usually too high for most program material.

Two examples for using the expander are as follows.

1. To reduce background noise (hum, hiss or scratch):
 - a. Select the desired program source with the LISTEN input selector.
 - b. Increase the VOLUME control during a quiet passage of the program until noise is clearly audible.
 - c. Turn the COMPANDOR selector knob to EXPAND. The Listen indicator will light over the COMPANDOR pushbutton.
 - d. Rotate the RATIO control clockwise until the noise is acceptably reduced.
 - e. Adjust the LEVEL MATCH control as described previously.
2. To improve the "live" sound of recorded or transmitted program material:

- a. Select the LISTEN input.
- b. Increase the VOLUME to a satisfactory level.
- c. Turn the COMPANDOR selector to EXPAND.
- d. Rotate the RATIO control clockwise until the dynamic range of the music, the ratio of loud to soft, is correct for you. The usual position will be between 1.2 and 1.5
- e. Adjust the LEVEL MATCH control as described previously.

USING THE COMPANDOR AS A COMPRESSOR

When the COMPANDOR selector is in the COMPRESS position, the RATIO control is used to select the amount of compression. Full counterclockwise rotation corresponds to a ratio of 1.0. The compressor output and input dynamic range will be the same. Set the VOLUME control to a normal listening level. As the RATIO control is increased clockwise the output dynamic range becomes less than the input range. Set the RATIO control to the desired compression. Switch the compressor on and off. A change in the average listening level will usually be heard. Adjust the LEVEL MATCH control until the average listening level matches as closely as possible when the compressor is switched on and off. After this adjustment you will notice that with the compressor on, loud passages will be softer and soft passages including noise will be louder.

When the RATIO control is at the fully clockwise position it corresponds to a ratio of 2.0. The output dynamic range is then one half of the input range. This setting can be useful to create highly compressed background music.

Using the Pushbuttons

COMPANDOR

The COMPANDOR pushbutton connects the compandor to either the listen or the record program line. The red indicator lights above the pushbutton will show that the compandor is connected to the LIS (listen) program line (pushbutton out) or to the REC (record) program line (pushbutton in). These lights will light only when the COMPANDOR knob is turned to the EXPAND or COMPRESS positions.

REC EQUAL

This pushbutton connects the EQUALIZER FREQUENCY controls to the listen or the record program lines. When the pushbutton is out, the equalizers are connected to the listen line. The red indicator light above the button will be off. When the pushbutton is in, the equalizers are connected to the record line. The red light will be on.

REC MONITOR

This pushbutton connects the C 33 main output to either the listen line or the record line. This pushbutton does not stay in after it is pushed as the others do. To change the switching status, push it again. Normal operation occurs when the red indicator light is off. The listen line is then connected to the C 33 output. When the light is on, the record line is connected to the C 33 output. This switch enables you to monitor what is being fed to the tape recorder.

To monitor the program from a tape recorder, turn the LISTEN input selector to TAPE 1, TAPE 2, or TAPE 3 as appropriate. To compare this program with the signal being fed into the recorder, press the REC MONITOR pushbutton so that the red indicator light is on. Press the REC MONITOR button a second time to listen to the recorder output again. The red indicator will then be off.

LF FILTER

The Low Frequency FILTER can be used only in the listen program line. When the pushbutton is out, the filter is out of the circuit and the red indicator

light will be off. When the pushbutton is in, the LF FILTER is in the circuit and the red light will be on. The filter is effective for all frequencies below 50 Hz and attenuates at the rate of 12 dB per octave. Use it to reduce undesirable low frequency noise such as rumble or mechanical feedback.

HF FILTER

The High Frequency FILTER affects only the listen program line. When the pushbutton is out the filter is out of the circuit and the red indicator light is off. When the pushbutton is in, the HF FILTER is in the circuit and the red light will be on. The filter is effective for all frequencies above 7,000 Hz and attenuates at the rate of 12 dB per octave. Use it to reduce undesirable high frequency noise such as record surface noise or tape hiss.

SPEAKER/OUTPUT 1 and 2

The SPEAKER/OUTPUT 1 and 2 pushbuttons can be used to control either the output jacks 1 and 2 or the main and remote speakers when the optional SPEAKER CONTROL RELAY (SCR) is connected. The SPEAKER/OUTPUT pushbuttons are not normally used to control connections to the OUTPUT 1 and 2 jacks and a SCR for speaker switching at the same time. The operation of the output jacks and speaker control will interfere with each other.

OUTPUT 1 AND 2

The output jacks 1 and 2 are located on the rear panel of the C 33. Signals from output 1 and 2 are the same as the main output. When the front pushbuttons are out, the listen program line is not connected to output jacks 1 and 2 and the red indicator lights are off. When one or both pushbuttons are IN, the listen line is connected to the corresponding pair of output jacks and the appropriate indicator light will be on. The C 33 output can then be switched to additional amplifiers or other devices. Additional amplifiers can serve remote areas such as selected living areas, workshop, or outdoor recreational facilities. Other devices can be controll-

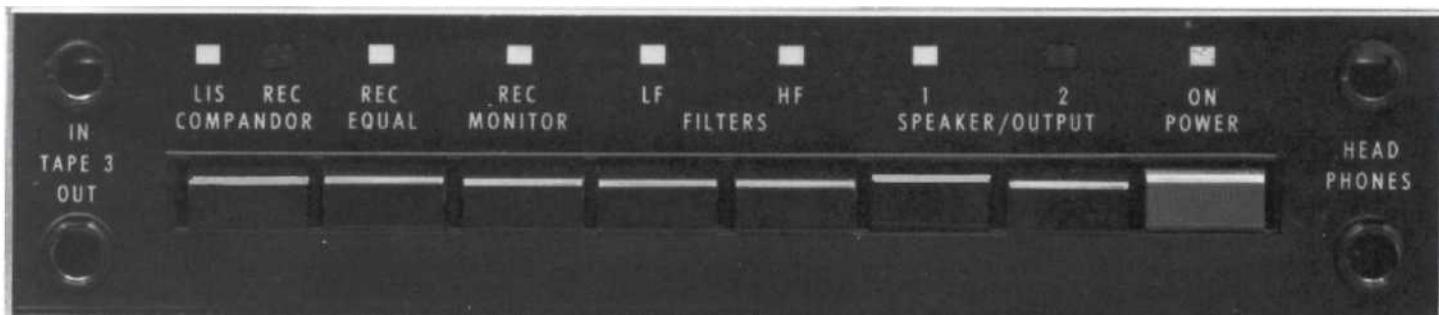

ed such as rear channel reverberation units, color displays, etc. For example Output 1 or 2 can be connected to a reverberation device and then to the C 33 monitor amplifier and a set of rear loudspeakers. (The monitor amplifier switch must be in the EXTERNAL position.) Rear channel reverberation can then be switched in and out without the need for an extra amplifier.

SPEAKER 1 AND 2 USING THE SCR

When pushbutton 1 is in and pushbutton 2 is out, the MAIN speakers will be connected to the power amplifier via the relays in the SCR. The red light above 1 will be on. When pushbutton 1 is out and pushbutton 2 is in, the remote speakers will be connected instead. The red light above 2 will be on. When both pushbuttons 1 and 2 are in, both sets of speakers will be connected and lights 1 and 2 will be on. CAUTION: When both sets of speakers are connected at the same time, their combined parallel impedance must not be too low for the power amplifier to handle. For example: If both sets of speakers are 8 ohms, connections to the power amplifier must be to the 4 ohm tap. If the amplifier does not have different impedance taps, it must be able to deliver power to a 4 ohm load as well as an 8 ohm load.

POWER ON

The red pushbutton turns the C 33 on and off. When the power is on, the panel illuminates and the red light above this pushbutton will go on. The turntable can also be used as a power switch. See page 8.



Top Panel Information and Secondary Controls

COMPANDOR

Operation of the LEVEL MATCH and SPEED controls is explained on page 13 under the Compandor System description.

AUTO-ON SENSITIVITY

The SENSITIVITY control is located at the right of the C 33 top panel. For normal operation with most turntables, the control can be left at mid-position. Some turntables, however, have electronic circuits that draw current whether they are turned "off" or not. The C 33 AUTO-ON SENSITIVITY control can be used to "fine tune" for the smaller difference between on and "off" currents.

If your turntable does not control the AUTO-ON feature of the C 33 correctly, use one of the following procedures:

1. Switch on the turntable. If the C 33 does not go on, or goes on but does not stay on, rotate the AUTO-ON SENSITIVITY control clockwise towards MAX until the C 33 goes on and stays on. Then check for proper operation.
2. Switch off the turntable. If the C 33 does not go off, rotate the AUTO-ON SENSITIVITY control counterclockwise towards MIN until it does go off. Check for proper operation.

If this doesn't correct the problem, your turntable probably has electronic circuits that draw the same or nearly the same current whether on or off. AUTO-ON control is not possible when using this turntable. The green AC outlet can still be used but the AUTO/

MANUAL switch must be set in the MANUAL position. The red POWER pushbutton must be used instead.

In the event you are using two record players, adjust the SENSITIVITY control as described above with both turntables connected to the C 33 green outlets. Start with both turntables switched off, and then one at a time switched on.

MONITORAMPLIFIER

HEADPHONES

The built-in Monitor Amplifier can drive headphones, loudspeakers, or provide a low impedance line output. The input to the Monitor Amplifier is selected by the INPUT switch located near the center of the C 33 top panel. This switch selects the LISTEN program, RECORD program, or separate EXTERNAL input. For normal listening use the LISTEN position.

The Monitor Amplifier LEFT and RIGHT GAIN controls are located to the left of the INPUT switch. When the switch is in the LISTEN position, the LEFT and RIGHT GAIN controls regulate the monitor volume along with the main front panel VOLUME control. When the INPUT switch is in the RECORD or EXTERNAL position, only the LEFT and RIGHT GAIN controls regulate the monitor volume.

The monitor amplifier can be used with any low impedance dynamic headphones. High impedance headphones will work but at a reduced listening level.

Performance Limits and Ratings

PERFORMANCE LIMITS

Performance limits are the maximum deviation from perfection permitted for a McIntosh instrument. We promise you that when you purchase a new C 33 from a McIntosh franchised dealer, it will be capable of or can be made capable of performance at or exceeding these limits or you can return the unit and get your money back. McIntosh is the only manufacturer that makes this statement.

PREAMPLIFIER SECTION

FREQUENCY RESPONSE

+ 0, -0.5dB from 20Hz to 20,000Hz

MAXIMUM VOLTAGE OUTPUT

10 volts from 20Hz to 20,000Hz

TOTAL HARMONIC DISTORTION

0.01% maximum from 20Hz to 20,000Hz at rated output

SENSITIVITY

Phono- 2mV for 2.5V rated output
(0.4mV IHF)

High Level- 250mV for 2.5V rated output
(50mV IHF)

SIGNAL TO NOISE RATIO, A-WEIGHTED

Phono- 90dB below 10mV input
(84dB IHF)

High Level- 100dB below rated output
(86dB IHF)

MAXIMUM INPUT SIGNAL

Phono- 100mV

High Level- 10 volts

INPUT IMPEDANCE

Phono- 47k ohms and 65pf capacitance
High Level- 50k ohms

EQUALIZATION CONTROLS

Variable 12dB boost to 12dB cut at center frequencies of 30, 150, 500, 1500, 10k Hz

COMPANDOR RATIOS

From 1:2 compression to 2:1 expansion

LF FILTER

Flat or roll-off at 12dB per octave below 50 Hz.

HF FILTER

Flat or roll-off at 12dB per octave above 7,000 Hz.

MONITOR AMPLIFIER SECTION

CONTINUOUS AVERAGE POWER OUTPUT

20 watts per channel into 8 ohms, from 20Hz to 20kHz, at 0.01% maximum harmonic distortion

FREQUENCY RESPONSE

+ 0 -0.2dB from 20Hz to 20,000Hz

SENSITIVITY

750mV for rated output (170mV IHF), input impedance is 27K ohms

SIGNAL TO NOISE RATIO, A-WEIGHTED

100dB below rated output (87dB IHF)

GENERAL INFORMATION

SEMICONDUCTOR COMPLEMENT

31 Bipolar Transistors

76 Field Effect Transistors

35 Integrated Circuits

107 Diodes

1 Silicon Controlled Rectifier (SCR)

AC POWER OUTLETS

2 turntable current-sensing, 100 watts, green

4 switched, 1200 watts total, black

POWER REQUIREMENTS

120 volts, 50/60 Hz, 25 to 85 watts

MECHANICAL INFORMATION

SIZE:

Front panel measures 16 inches wide (40.6 cm) by 5-7/16 inches high (13.8 cm). Chassis measures 15 inches wide (38.1 cm) by 5 inches high (12.7 cm) by 13 inches deep (33.0 cm), including PANLOC shelf and back panel connectors. Knob clearance required is 1-1/2 inches (3.81 cm) in front on the mounting panel.

FINISH:

Front panel is anodized gold and black with special gold/teal nomenclature illumination. Chassis is black.

MOUNTING:

Exclusive McIntosh developed professional PANLOC

WEIGHT:

26 pounds (11.8 kg) net, 38 pounds (17.2 kg) in shipping carton

Performance Charts

FREQUENCY RESPONSE

- IN: AUX; OUT: MAIN
- - - - LF AND HF FILTERS
- - - - MONITOR AMPLIFIER

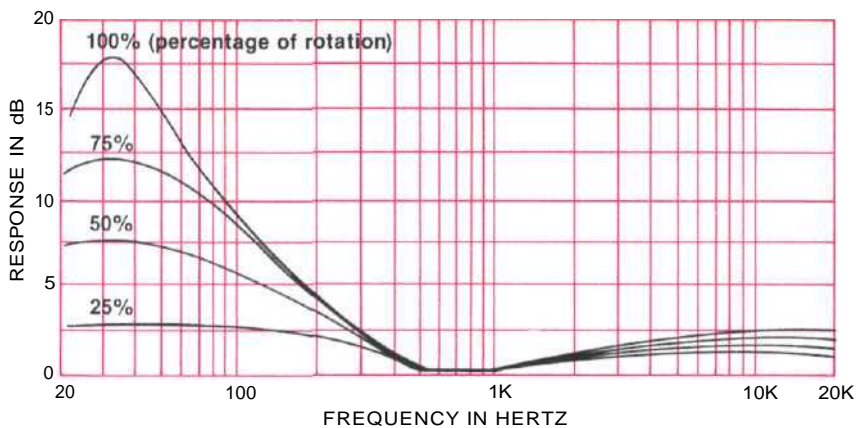
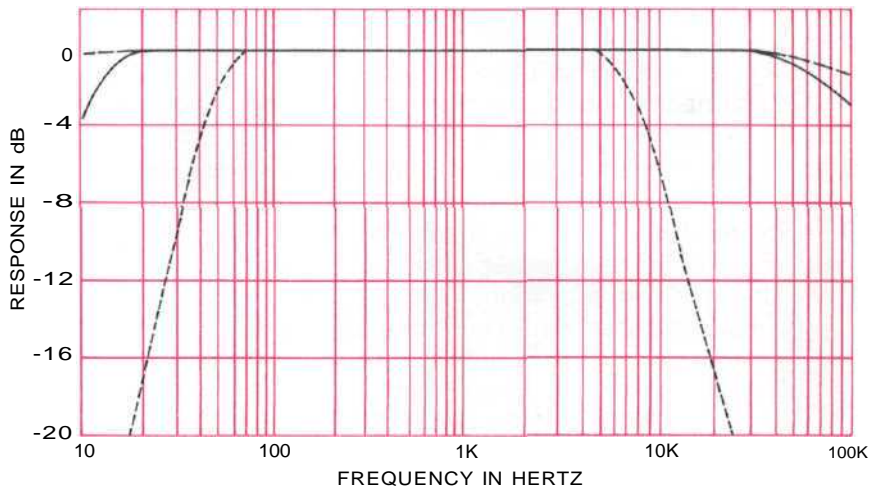

LOUDNESS CONTROL RESPONSE FOR VARIOUS CONTROL POSITIONS

EQUALIZER FREQUENCY RESPONSE CONTROLS SET AT MAXIMUM AND MINIMUM

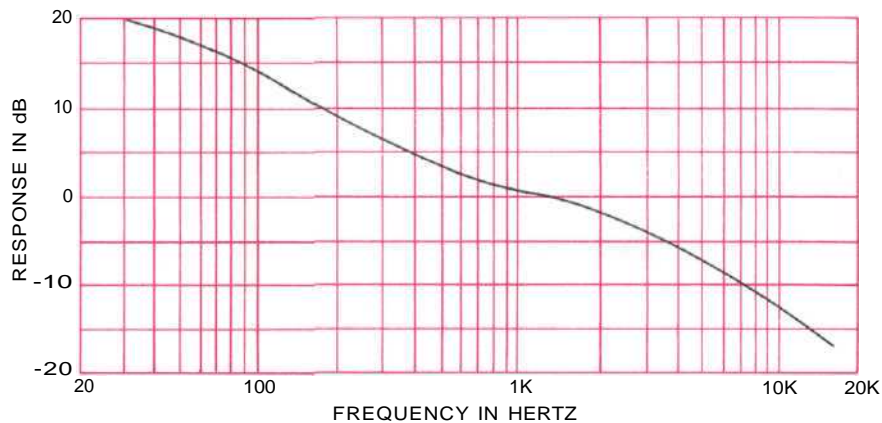
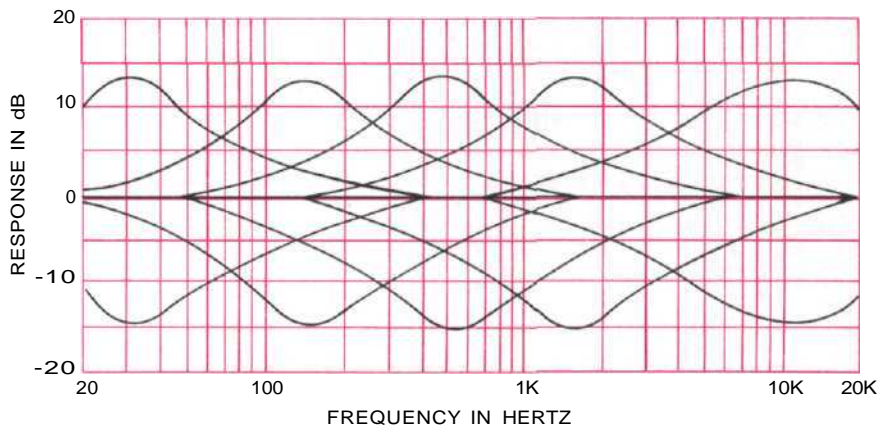

RIAA EQUALIZATION CURVE

PHONO HARMONIC DISTORTION
AT 2.5 VOLTS OUTPUT

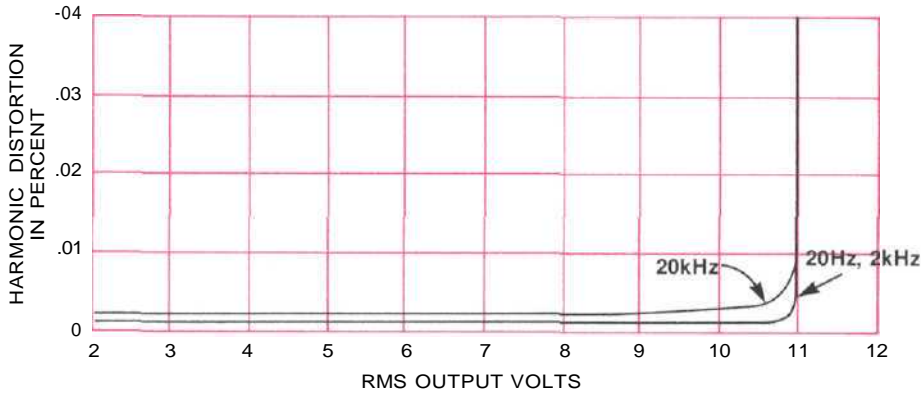
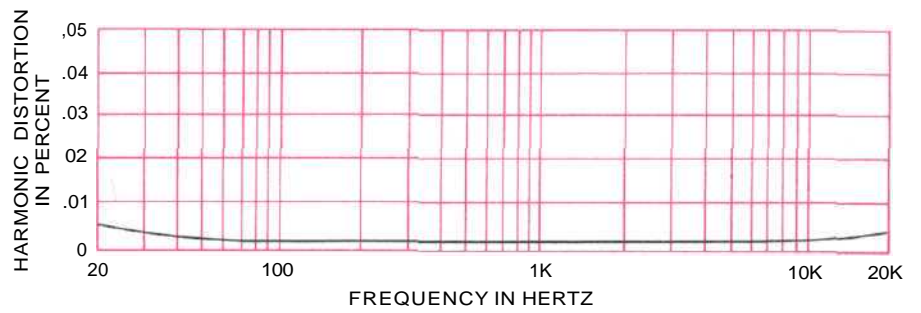

HARMONIC DISTORTION
IN: AUX; OUT: MAIN

INTERMODULATION DISTORTION
IN: AUX; OUT: MAIN
INPUT FREQUENCY: 60Hz & 7kHz
RATIO: 4:1

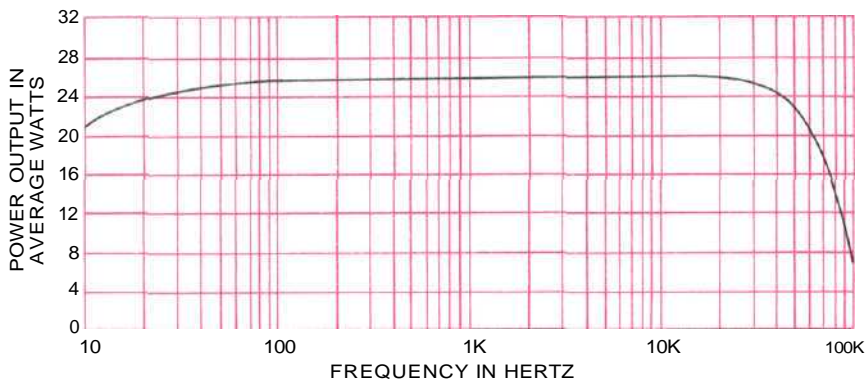
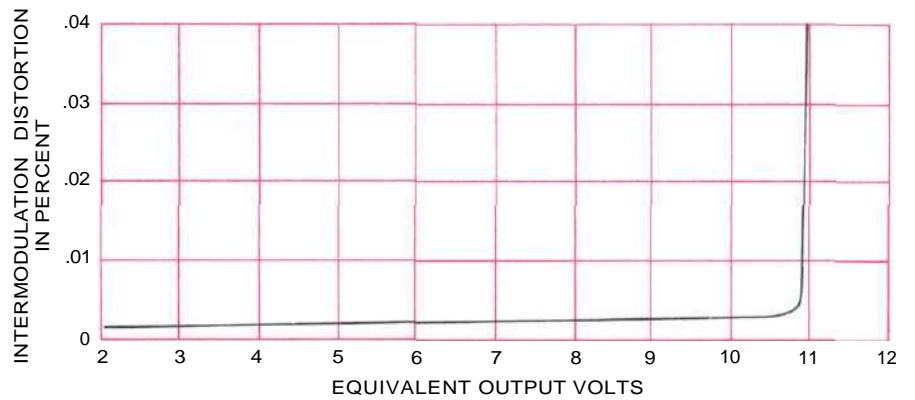

MONITOR AMPLIFIER POWER BANDWIDTH
AT .02% T.H.D., 8 OHMS

MONITOR AMPLIFIER HARMONIC
DISTORTION 20 WATTS OUTPUT
PER CHANNEL, 8 OHMS



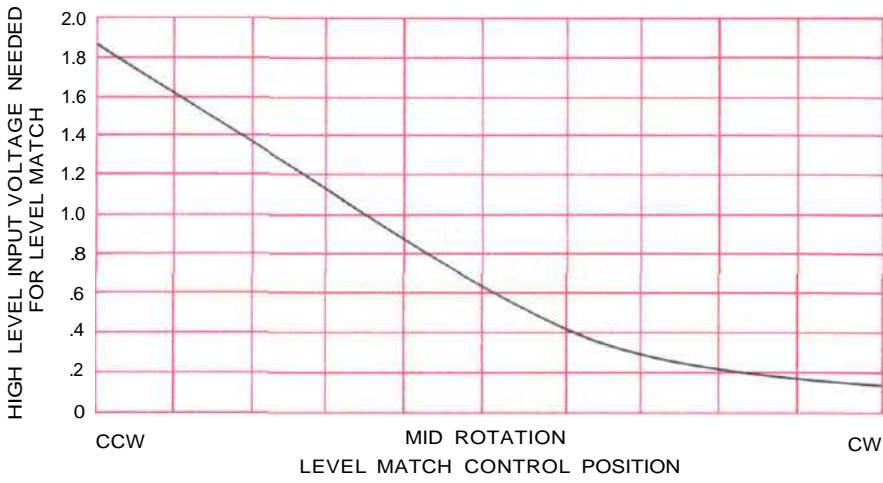

COMPANDOR LEVEL MATCH RANGE

COMPANDOR EXPANSION AND COMPRESSION CHARACTERISTICS

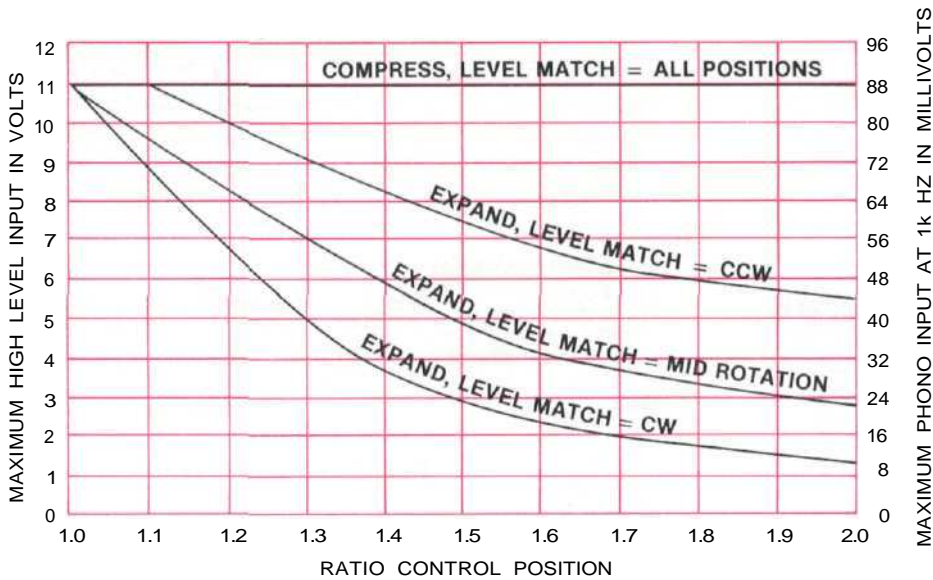
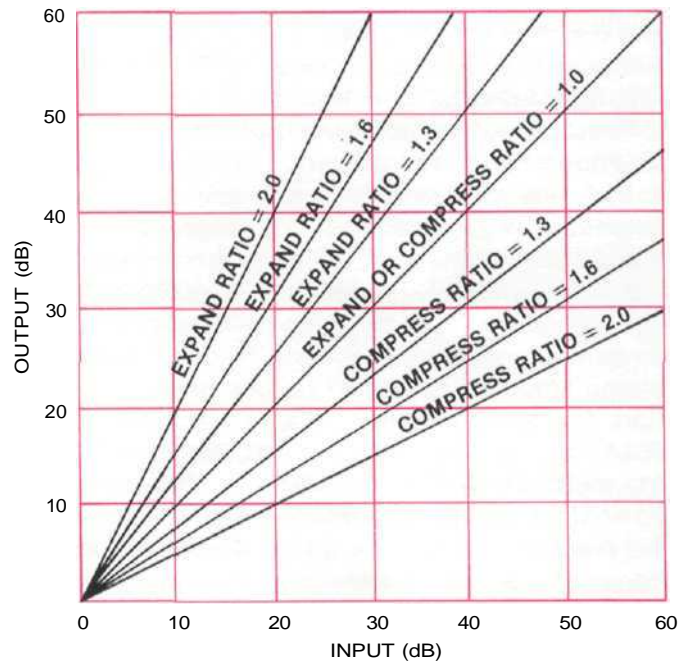

COMPANDOR INPUT VOLTAGE LIMIT

Technical Description

The simplified block diagram on page 3 and the detailed block diagram on page 24 show how the C 33 internal circuits are arranged. The C 33 uses separate program channels (referred to as "program lines" in this manual) for "listening" and "recording". This allows you to listen to any program source while you record from another or the same program source. The mode selector, volume control, loudness control, balance control, and LF and HF filters are in the Listen program line only. The compandor, the five equalizer frequency controls, and the monitor amplifier can be individually switched to the Listen program line or the Record program line. A description of the C 33 circuits follows.

PHONO AMPLIFIER

Four separate phono amplifiers are provided; two for Phono 1 and two for Phono 2. Each amplifier uses a high technology integrated circuit operational amplifier. Its differential input stage has been optimized for low noise and low distortion performance. Open loop gain of this integrated circuit is 100,000 times. With high open loop gain a large amount of negative feedback is used around the phono amplifier to further reduce noise and distortion. The feedback network also provides precision RIAA frequency compensation. The network uses 1 % metal film resistors and 5% poly film capacitors. To achieve low noise performance it is essential that the feedback network have very low impedance. As a consequence, the preamplifier must be capable of operating as a power amplifier to drive this impedance. The actual power output capability of this preamplifier stage is more than 100 milliwatts, a great margin beyond that which is required.

Input sensitivity of the phono amplifier is 2.2 millivolts. The gain of the amplifier is 42 dB at 1000 Hz. The phono amplifier has a very wide dynamic range. At 1000 Hz the phono input circuit will accept 100 millivolts without overload, a voltage far greater than the output of any magnetic phono cartridge presently available.

LISTEN AND RECORD SELECTOR SWITCHES

Input switching is accomplished electronically. Signals from the 7 inputs connect to two arrays of Field Effect Transistors (FET) to perform the switching. Control signals from the Listen and Record selector switches turn on the appropriate FET switches to pass the selected input signals. The other input signals are blocked by the "off" FET switches. Each FET switch uses two cascaded FET transistors to provide the required isolation and pre-

vent cross talk between inputs. The FET "on" resistance is very low which prevents distortion. The switching transistors are located right at the input jacks, so that signal wiring is kept to a minimum. This eliminates cross talk and noise problems.

LISTEN PROGRAM LINE

The listen program signal from the Listen input switch goes to the Compandor control switching where the Compandor can be inserted in either the listen or the record program path. The Compandor circuit is described later.

The listen program then goes to the Listen External Processor jacks. These jacks have switching contacts so that the signal passes through when there is no plug in the jacks. Therefore, if an External Processor is used, the Listen program leaves the C 33 through the External Processor "to" jack and returns via the "from" jack. If no processor is used, the signal passes directly through the jacks.

The volume control is the next step in the listen path. The volume control is a step attenuator which has left to right tracking accuracy within 1 dB throughout its entire range. Such extremely accurate matching is achieved through electronically controlled trimming of the resistance material deposited on pairs of printed circuits. Since the switch commutator touches only contact pads and not the actual resistance element, tracking accuracy is not degraded with use as in ordinary volume controls.

The loudness control and its amplifiers follow the volume control. In the past, loudness controls have typically used simple passive circuits connected to a tap on the volume control. As a consequence, compensation accuracy was dependent on many variables such as volume control position and differences in the input level. The C 33 loudness control uses active circuits. An integrated circuit operational amplifier is used here. It has two feedback loops. One has flat frequency response. The other has response conforming to the Fletcher-Munson equal loudness contours. A potentiometer is placed between these two feedback loops making it possible to select any combination of the two, from a flat response to full loudness compensation. The overall gain of the stage is 20 dB at mid-frequencies and the listening volume is not affected by the position of the loudness control.

The listen program signals next pass to the balance control and then to the Equalizer Amplifier. This amplifier uses a low noise operational amplifier and has flat response and unity gain. Five other opera-

tional amplifiers are arranged in circuit configurations that are equivalent to five series tuned circuits, each at one of the equalizer frequencies. These series tuned circuits are inserted via control potentiometers into either the input circuit or feedback circuit of the equalizer amplifier. This provides a boost or cut capability of 12 dB for each equalizer band of frequencies. A pushbutton switch allows the equalizer circuit to be switched from the Listen program line to the Record program line.

The LF and HF Filters follow next. These filters are active filters using operational amplifiers. When switched in, the LF filter attenuates frequencies below 50 Hz at a rate of 12 dB per octave. The HF Filter attenuates frequencies above 7kHz at a rate of 12 dB per octave.

The Listen program signal then arrives at the main output jacks. The main jacks are fed directly. The output 1 and output 2 jacks receive the same signal but can be turned on and off by the Speaker/Output 1 and 2 pushbuttons.

RECORD PROGRAM LINE

The record program signal from the Record input switch goes first through a unity gain amplifier and then to the Comandor switching where the Comandor can be inserted into the record program path. The Comandor circuit is described later. The Record program then goes to the Record External Processor jacks. These jacks, like the Listen External Processor jacks, have switching contacts so that the signal passes through when there are no plugs in the jacks. Therefore, if an External Processor is used, the Record program leaves the C 33 through the External Processor "to" jack and returns via the "from" jack. If no processor is connected the signal passes directly through the jacks.

An equalizer amplifier with unity gain follows next. A pushbutton switch allows the 5 band equalizer controls to be switched from the Listen program line to the Record program line. This feature allows equalizing the record signal before it is fed to a recorder.

The equalizer amplifier feeds to electronic interlock switching and then finally to the record output jacks. The switching is arranged so that if the Record input selector is positioned to select the output of a recorder, the Record program line will not feed the record output jack connected to that recorder. This prevents recorder feedback.

COMPANDOR

The Comandor will expand or compress the dynamic range of the program material. The Comandor can be switched to the Listen or Record program lines or turned off. Program to the Comandor is applied to a voltage controlled amplifier (VCA) which operates as a variable gain block. Control

voltages for this VCA are developed from a sample taken from the left and right channel input signals to the VCA. The electronic processing of this sample is detailed. It includes band shaping, logarithmic conversion, full wave rectification, level setting, expansion or compression ratio regulation, attack timing, and DC amplification. The resulting processed voltage controls the gain of the VCA to cause logarithmic gain expansion when expanding the program, or the opposite, logarithmic gain compression when compressing the program.

MONITOR AMPLIFIER

The monitor amplifier is a 20 watt per channel stereo power amplifier. The monitor input selector switch allows the amplifier to be driven from the Listen or Record program lines or from an external input. This amplifier is a push pull complementary class AB amplifier using a differential input stage. The amplifier includes McIntosh's Power Guard protection circuit. The Power Guard circuit compares the amplifier output signal with its input signal. If there is a difference between the waveforms of these signals, Power Guard activates an electronic attenuator at the input of the amplifier which reduces the amplifier input level. This automatic control system makes it impossible to drive the monitor amplifier into clipping. Thus, clipping distortion and loudspeaker damage due to clipping are eliminated.

AUTO TURN-ON

A turntable plugged into the green outlets at the rear of the C 33 can control the on-off operation of the C 33. Current flow to the turntable is sensed and controls a silicon control rectifier (SCR). When the SCR conducts a relay closes. This relay turns on power to the C33 and to the black AC power outlets. A current sensing sensitivity control allows calibrating the Auto Turn-On circuit to the turntable used. Power is also controlled by the C 33 Power On pushbutton. The Auto Turn-On circuit may be switched off for manual power control.



Block Diagram

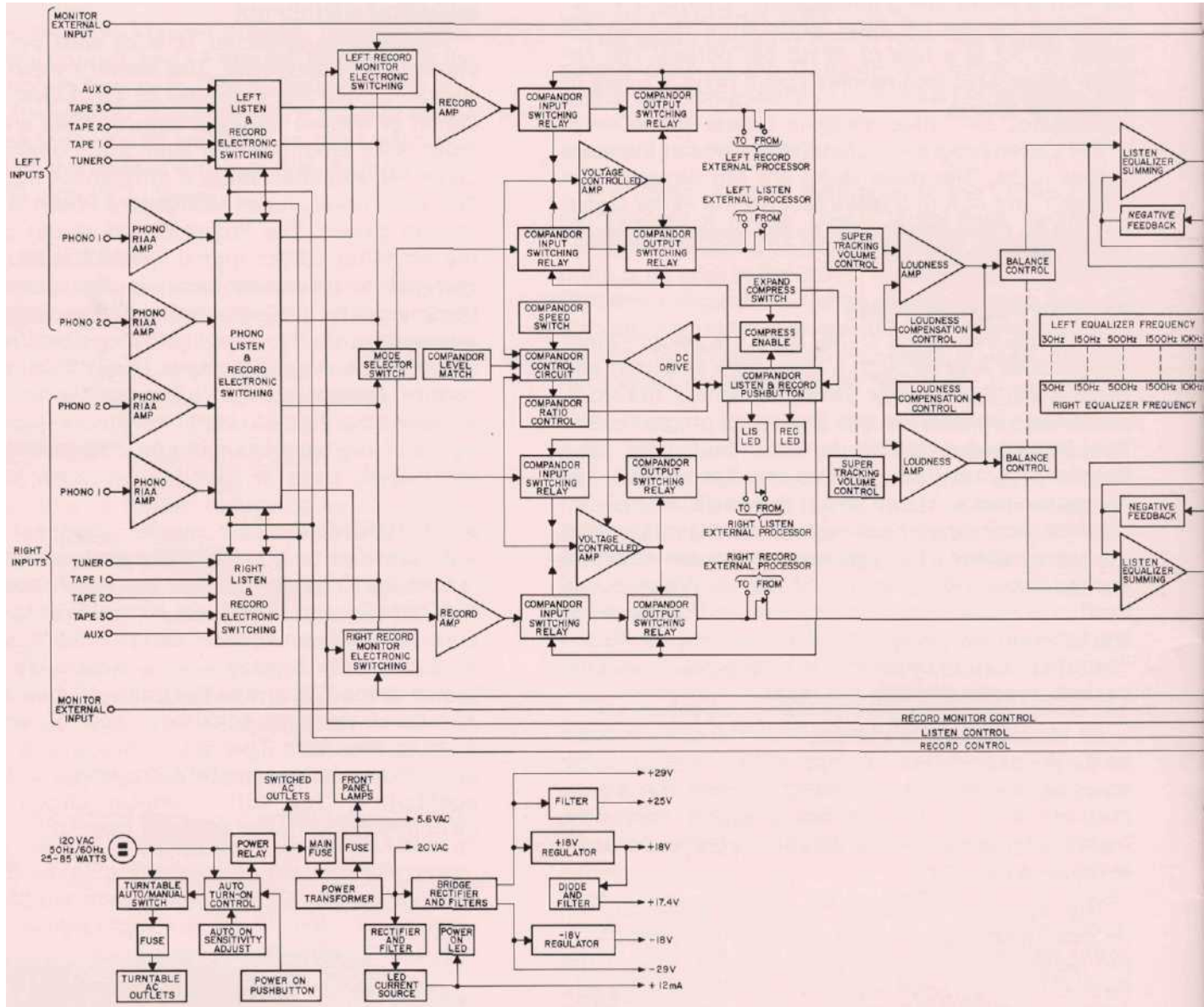

McINTOSH C33 STE

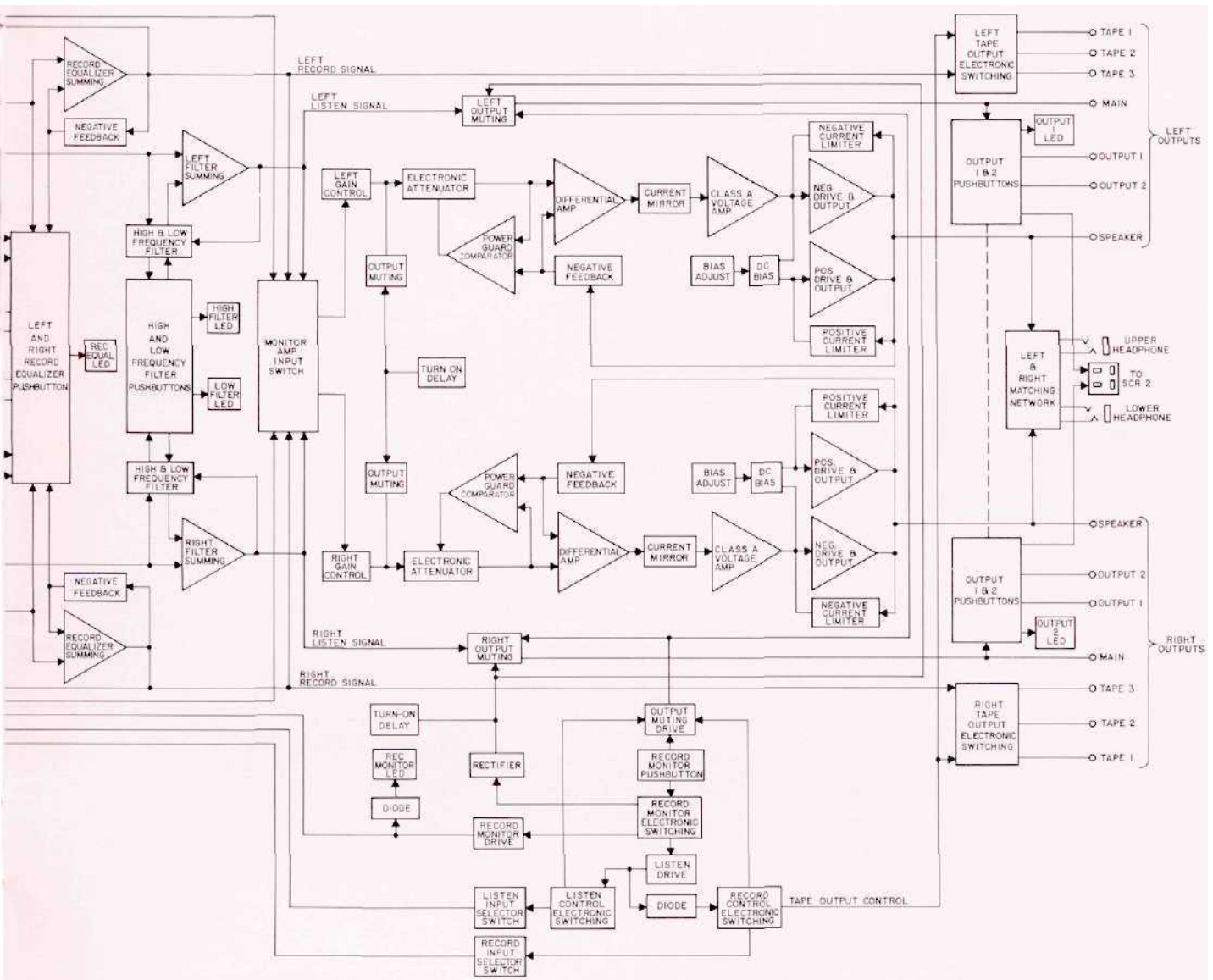

REO PREAMPLIFIER

McIntosh

**McINTOSH LABORATORY INC.
2 CHAMBERS ST., BINGHAMTON, N.Y. 13903-9990**

607-723-3512

The continuous improvement of its products is the policy of McIntosh Laboratory Incorporated, who reserves the right to improve design without notice.

Printed in U.S.A.